

# FICHE D'HOMOLOGATION / HOMOLOGATION FORM



050-TP-72



COMMISSION  
INTERNATIONALE  
DE KARTING - FIA

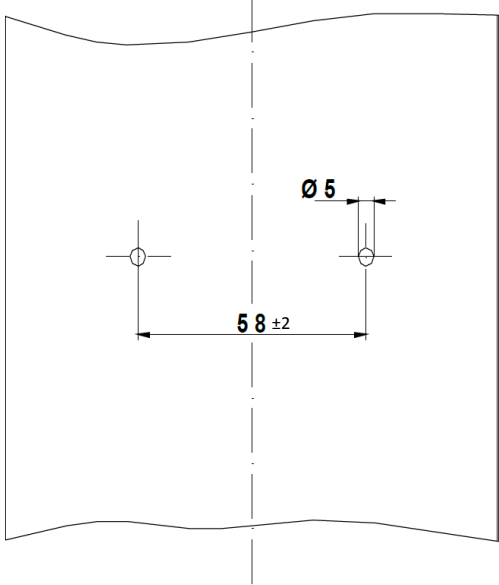

## PNEUMATIQUE / TYRE 5" SLICK PRIME

Constructeur / <i>Manufacturer</i>	Reifenwerk Heidenau GmbH&Co.KG
Marque / <i>Make</i>	<b>MOJO</b>
Modèle / <i>Model</i>	<b>D5 4.5/10.0-5</b>
Catégorie / <i>Categorie</i>	Group 1 & 2
Durée de l'homologation / <i>Validity of the Homologation</i>	3 ans / 3 years
Nombre de pages / <i>Number of pages</i>	4
La présente Fiche d'Homologation reproduit descriptions, illustrations et dimensions du pneumatique au moment de l'homologation CIK-FIA.	<i>This Homologation Form reproduces descriptions, illustrations and dimensions of the tyre at the moment of the CIK-FIA homologation.</i>
	
Photo du pneu monté sur la jante / <i>Photo of the tyre fitted to the rim</i>	Dessin de la bande de roulement / <i>Tread design drawing</i>
Signature et tampon de l'ASN / <i>Signature and stamp of the ASN</i>	Signature et tampon de la CIK-FIA / <i>Signature and stamp of the CIK-FIA</i>
	

Descriptions Techniques	Technical Descriptions
Sous une température de 23°C +/-2°C, avec une humidité de 50% +/-5%	At a temperature of 23°C +/-2°C and with a humidity of 50% +/-5%

Pt	Descriptions / Descriptions	Valeurs / Value		Tolérances / Tolerances	
1	Dimensions / Dimensions	4.5/10.0-5		--	
2	Désignation du mélange / Tread compound designation	D5		--	
3	Pression de service / Service pressure	0.6 bar		+/- 0.3 bar	
4	Pression de gonflage / Inflation pressure	4.0 bar		max.	
5	Capacité de charge / Load capacity	80 kg		max.	
6	Vitesse maximale / Maximum speed	180 km/h			
7	Rigidité latérale et verticale (sous charge de 40 kg) / Lateral and vertical stiffness (under 40 kg load)	V: 1.0 mm L: 13.0 mm		L: +/-1 V: +/-2	
8					
9	Profondeur du profil / Depth of tread	3.5 mm		+/- 0.5 mm	
10	Poids en grammes / Weight in grams	1190		+/- 10%	
11	Nombre de plis / Numbers of plies	2		--	
12	Épaisseur de la bande de roulement / Tread thickness	4.5 mm		+/- 1.0 mm	
13	Nombre d'indicateurs d'usure du pneu / Number of tread wear indicators	8		--	
14	Matériau de la carcasse / Carcass material	Polyester		--	
15	Angle de tissage de la toile du pneu / Angle of tyre canvas	30°		+/- 3°	
16	Type de fil de tissage (selon ISO) / Canvas thread type (according to ISO)	1100		--	
17	Pneu tubeless / Tubeless tyre	Yes		--	
18	Dureté superficielle de la bande de roulement (ISO 48:2018 – 2 échantillons de 2 mm d'épaisseur) / Superficial tread hardness (ISO 48:2010 – 2 samples of 2 mm thickness)	34.1		+/- 5 DIDC - IRHD	
19	Contrainte-déformation en traction (ISO 37:2017 – éprouvette type 3) / Tensile stress-strain (ISO 37:2017 – type 3 sample)	à / at 100%	à / at 300%	à / at 100%	à / at 300%
		1.2	6.2	+/- 0.5 MPa	+/- 0.8 MPa

Dessin

Drawing

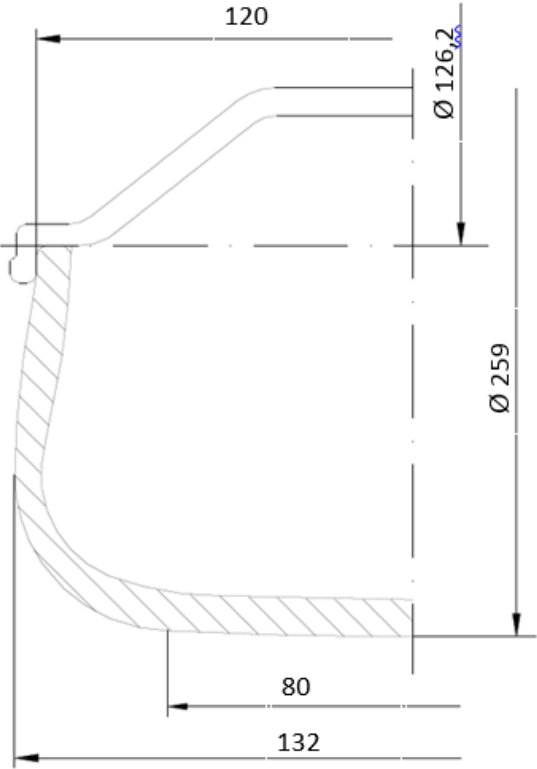
Dessin du pneu en section transversale et dimensions du pneu monté sur une jante / Drawing of tyre cross section and dimensions of the tyre fitted to a rim	Dimensions / Dimensions	Tolérances / Tolerances
	Ø 259 mm	+/- 5.0 mm
	Ø 126.2 mm*	+0/-1.0 mm
	132 mm	+/- 3.0 mm
	80 mm	+/- 3.0 mm
	120 mm	+/- 2.0 mm
<p>*Dimension selon Dessin Technique N° 4 jante 5" standardisée / Dimension according to Technical Drawing N° 4 standardised 5" rim</p>		

DESSIN TECHNIQUE N°4

Jante 5"

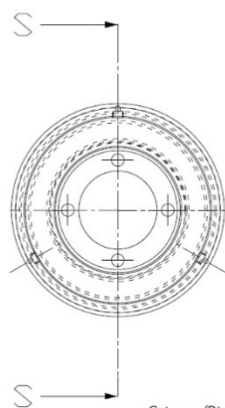



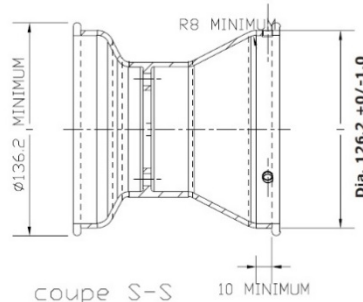

Cotes en/Dimensions in mm

TECHNICAL DRAWING No. 4

5" Rim



coupe S-S 10 MINIMUM

Photos et Inscriptions	<i>Photos and Inscriptions</i>		
Seules les inscriptions qui ne changeront pas tout au long de la fabrication sont reportées ci-dessous.	<i>Only the inscriptions which will not change during production are mentioned below.</i>		
Photo du flanc extérieur du pneu / <i>Photo of tyre external sidewall</i>	Inscription sur le flanc extérieur du pneu / <i>Inscriptions on tyre external sidewall</i>		
	<b>Texte / Text</b>	<b>Hauteur / Height</b>	<b>Trait / Stroke</b>
	MOJO (printed)	11 mm	2.5 mm
	4.5/10.0 – 5	7 mm	2.0 mm
	TUBELESS	4 mm	0.5 mm
	MADE IN GERMANY	3 mm	0.5 mm
		8 mm	
	FOR RACING PURPOSE ONLY	4 mm	0.5 mm
	MAX. INFLATION PRESSURE 4.0 BAR/ 58 PSI	4 mm	0.5 mm
Photo du flanc intérieur du pneu / <i>Photo of tyre internal sidewall</i>	Inscription sur le flanc intérieur du pneu / <i>Inscriptions on tyre internal sidewall</i>		
	<b>Texte / Text</b>	<b>Hauteur / Height</b>	<b>Trait / Stroke</b>
	MOJO	16 mm	5.0 mm
	D5	5 mm	0.5 mm
	4.5/10.0 – 5	7 mm	2.0 mm
	TUBELESS	4 mm	0.5 mm
	MADE IN GERMANY	3 mm	0.5 mm
		8 mm	
	FOR RACING PURPOSE ONLY	4 mm	0.5 mm
	MAX. INFLATION PRESSURE 4.0BAR/ 58 PSI	4 mm	0.5 mm
	CIK	6 mm	2.0 mm
Prime	5 mm	0.5 mm	